



SD4

MONOBLOCK
DIRECTIONAL CONTROL VALVES



Features

Simple, compact designed, this valve is only one section for open centre and closed centre hydraulic systems.

H Fitted with a main pressure relief valve.

H Diameter 16 mm - 0.63 in interchangeable spools.

H Available manual and remote with flexible cables spool control kits.

Working conditions

This catalogue shows technical specifications and diagrams measured with mineral oil of 46 mm²/s - 46 cSt viscosity at 40°C temperature.

Nominal flow rating		45 l/min	
Operating pressure (maximum)		250 bar	3600 psi
Back pressure (maximum)	on outlet port T	25 bar	260 psi
Internal leakage A(B)→T	$\Delta p = 100 \text{ bar} - 1450 \text{ psi}$ fluid and valve at 40°C - 104°F	3 cm ³ /min	0.18 in ³ /min
Fluid		Mineral base oil	
Fluid temperature	with NBR (BUNA-N) seals	from -20° to 80°C	
	with FPM (VITON) seals	from -20° to 100°C	
Viscosity	operating range	from 15 to 75 mm ² /s	from 15 to 75 cSt
	min.	12 mm ² /s	12 cSt
	max.	400 mm ² /s	400 cSt
Max level of contamination		19/16 - ISO 4406	
Ambient temperature		from -40° to 60°C	

NOTE - For different conditions please contact Customer Service.

Additional information

This catalogue shows the product in the most standard configurations.

Please contact Customer Service Dpt. for more detailed information or special request.

WARNING!

All specifications of this catalogue refer to the standard product at this date.

Walvoil, oriented to a continuous improvement, reserves the right to discontinue, modify or revise the specifications, without notice.

WALVOIL IS NOT RESPONSIBLE FOR ANY DAMAGE CAUSED BY AN INCORRECT USE OF THE PRODUCT.

7th edition October 2000:

This edition supercedes all prior documents.

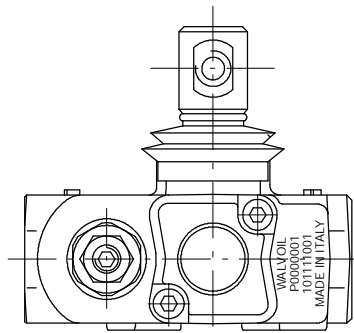

WALVOIL
P000001
10111001
MADE IN ITALY

Production batch :
 P00 = production year (2000)
 00001 = progressive number
 Valve code

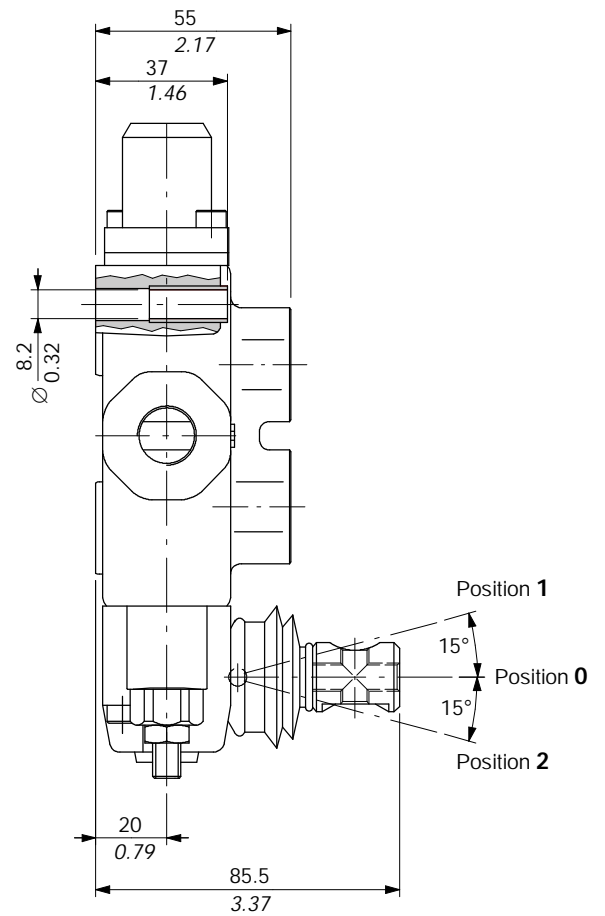
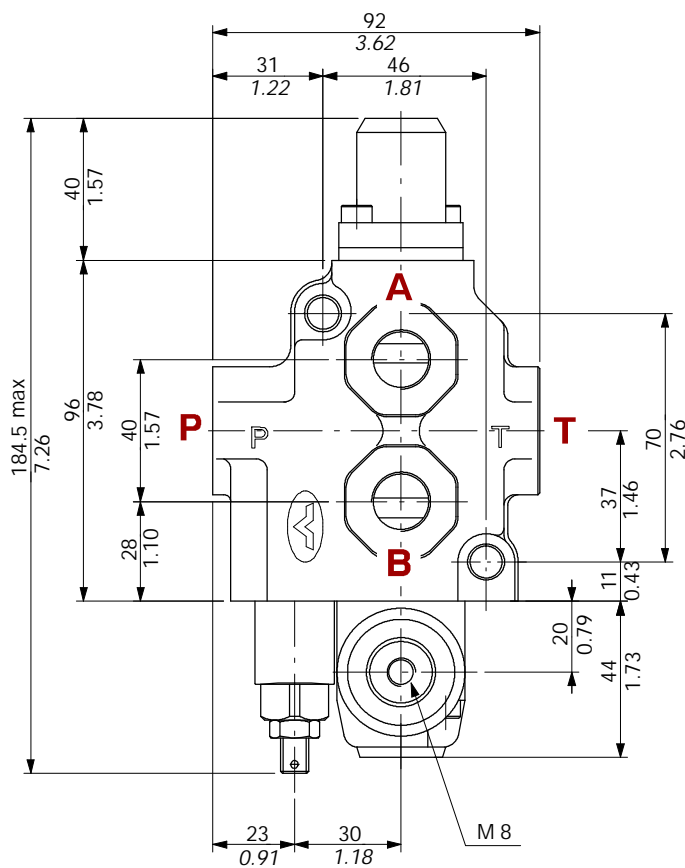

Standard threads

PORT	BSP (ISO 228/1)	UN-UNF (ISO 11926-1)	METRIC (ISO 262)
Inlet P		3/4-16 UNF-2B (SAE 8)	
A and B ports	G 3/8	9/16-18 UNF-2B (SAE 6)	M18x1.5
Outlet T		3/4-16 UNF-2B (SAE 8)	

SD4

Hydraulic circuit

Standard valve is supplied with positive overlap spool (1CP).

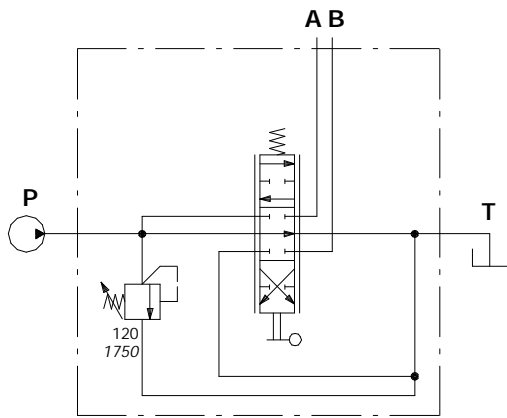

Ex.: SD4/1(KG3-120)/1CP8L

Right inlet

A symmetrical body allows the reverse assembly of spool and relative control kit and lever (ED configuration).

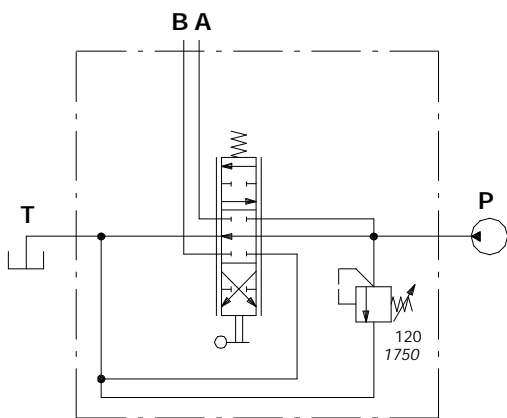

Ex.: SD4/1(KG3-120)/ED-1CP8L

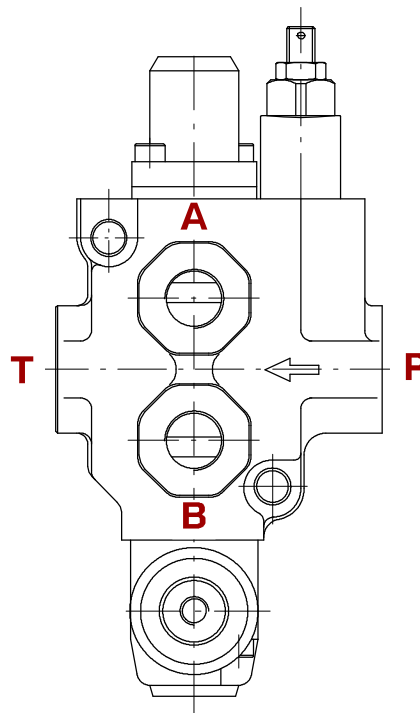

Performance data (pressure drop vs. flow)

Open centre

From inlet to outlet.

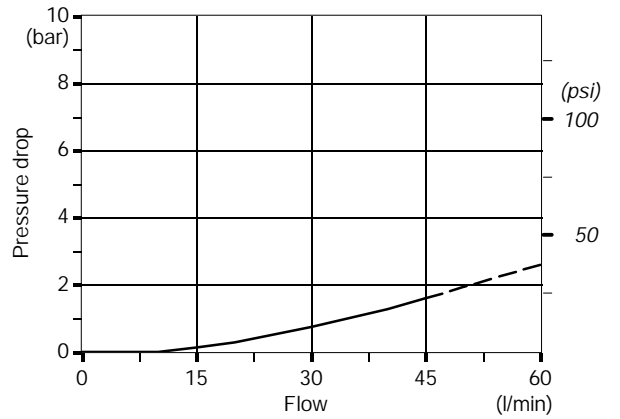
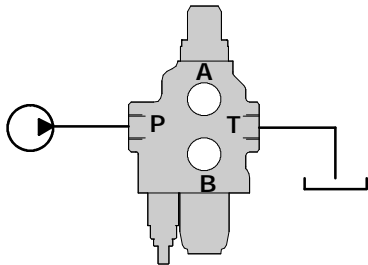

Inlet to work port

From inlet to A port (spool in position 1) or B port (spool in position 2).

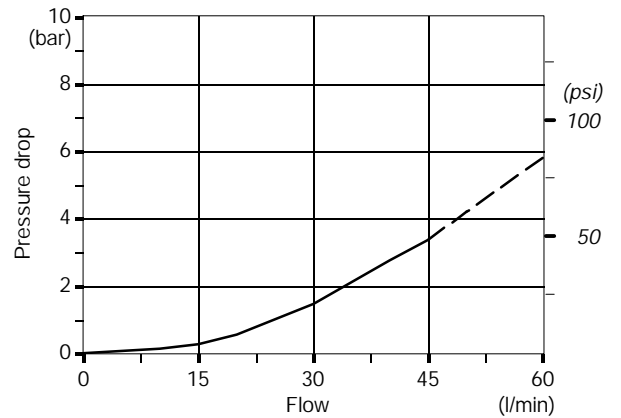
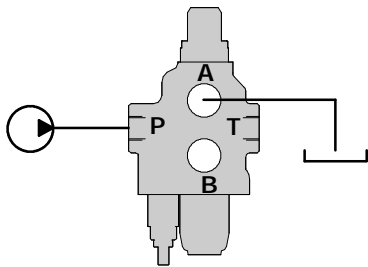

Work port to outlet

From A port (spool in position 2) or B port (spool in position 1) to outlet.

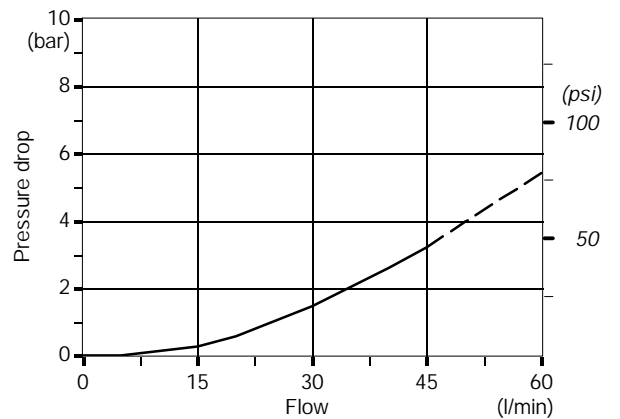
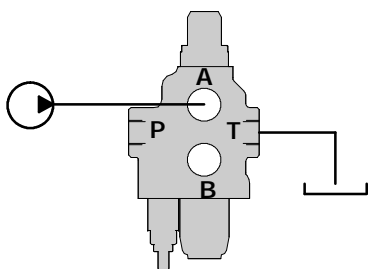

NOTE - Measured with spool type 1CP.

SD4

Ordering codes

Example:

SD4 / 1 (KG3-120) / 1CP 8 L *

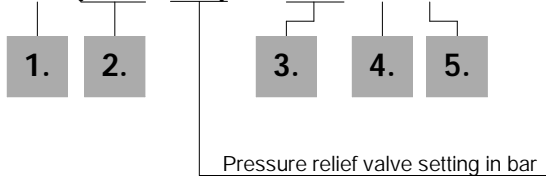

1. Body kits *

TYPE	CODE	DESCRIPTION
1	5KIT1113000	1 section

Include body and seals.

2. Inlet relief options

TYPE	CODE	DESCRIPTION
<u>VMD5/1 direct pressure relief valve type K (standard)</u>		
(KG2-80)	5KIT105122	Range 40 to 80 bar / 580 to 1150 psi standard setting 80 bar / 1150 psi
(KG3-120)	5KIT105123	Range 63 to 200 bar / 900 to 2900 psi standard setting 120 bar / 1750 psi
(KG4-220)	5KIT105124	Range 160 to 250 bar / 2300 to 3600 psi standard setting 220 bar / 3200 psi

VMD5/1 direct pressure relief valve type Y

(YG2-80)	5KIT105212	Range 63 to 160 bar / 900 to 2300 psi standard setting 80 bar / 1150 psi
(YG3-175)	5KIT105213	Range 125 to 250 bar / 1800 to 3600 psi standard setting 175 bar / 2500 psi

Standard setting is referred to 10 l/min flow.

SV	XTAP623282	Relief blanking plug
----	------------	----------------------

3. Spool options

TYPE	CODE	CIRCUIT DESCRIPTION
1CP	3CU1110110	Double acting with positive overlap, 3 positions, A and B closed in neutral position
1N	3CU1110120	Double acting, 3 positions, A and B closed in neutral position, negative overlap
2	3CU1125130	Double acting, 3 positions, with A open to tank in neutral position
3	3CU1131130	Single acting on A, 3 positions, B plugged; requires G3/8 plug (see part I)
4	3CU1135140	Single acting on B, 3 positions, A plugged requires G3/8 plug (see part I)
6	3CU1150130	Double acting, 3 positions, closed center
7	3CU1155130	Double acting, 3 positions, closed center with A and B to tank in neutral position

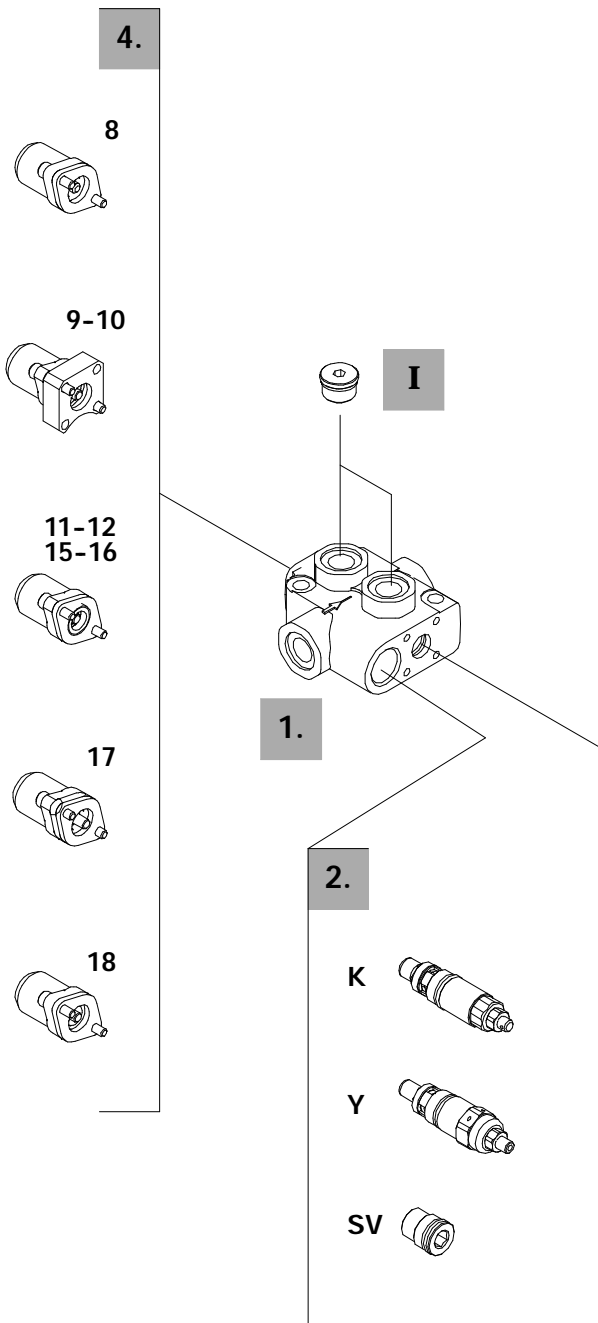

NOTE (*) - Items are referred to **BSP** thread.

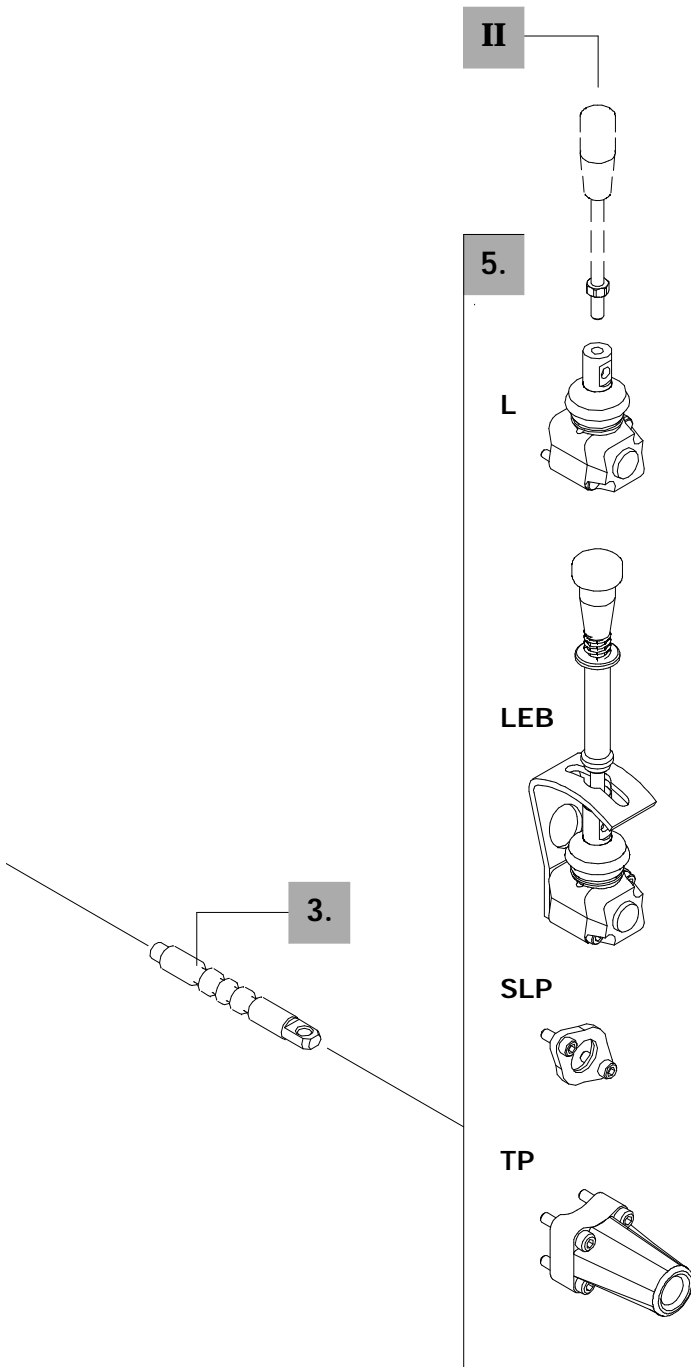

4. "A" side spool positioners

TYPE	CODE	DESCRIPTION
8	5V08104000	With spring return in neutral position
9	5V09104010	With detent in position 1
10	5V10104010	With detent in position 2
11	5V11104000	With detent in position 1, neutral and 2
12	5V12104000	With detent in position 1 and 2
15	5V15104000	With detent in position 1 and neutral
16	5V16104000	With detent in position 2 and neutral
17	5V17104000	With spring return position 1
18	5V18104000	With spring return position 2

5. "B" side options

TYPE	CODE	DESCRIPTION
L	5LEV105000	Standard lever box
LEB	5LEV605000	Safety lever with handlever, detent in 3 positions
SLP	5COP105000	Without lever, with dust proof plate
TP	5TEL105005	Cable connection

I Port plug *

TYPE	CODE	DESCRIPTION
G3/8	3XTAP722160	Plug for single acting spool

II Optional handlever

TYPE	CODE	DESCRIPTION
AL01/M8x120	170011012	Standard handlever L= 120mm/4.72in

For special configurations see pages 9 and 10

Spools options

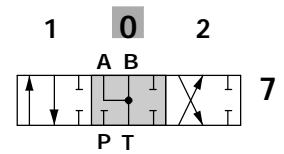
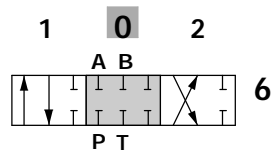
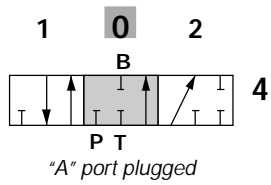
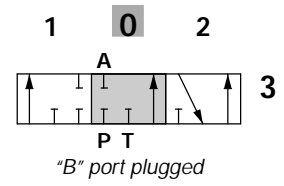
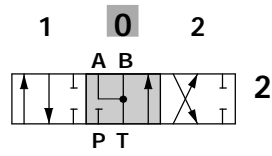
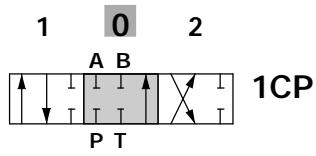

"A" side spool positioners

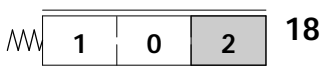
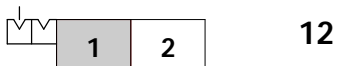
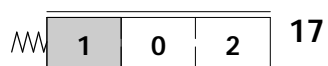
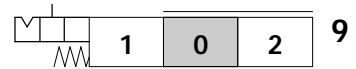
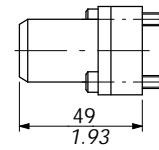
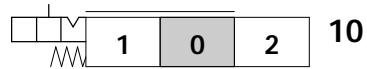
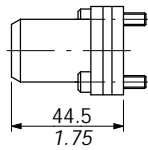
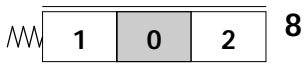
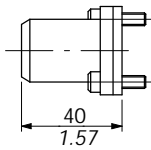

Directional valve with rotary control kit

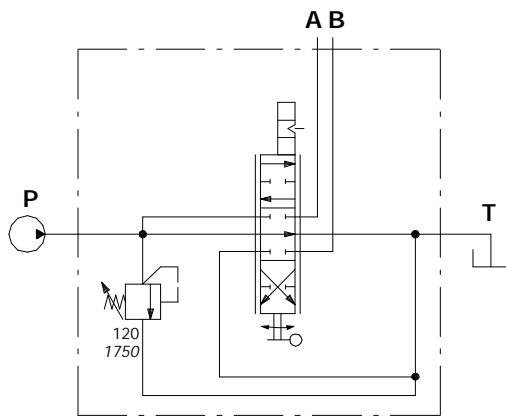
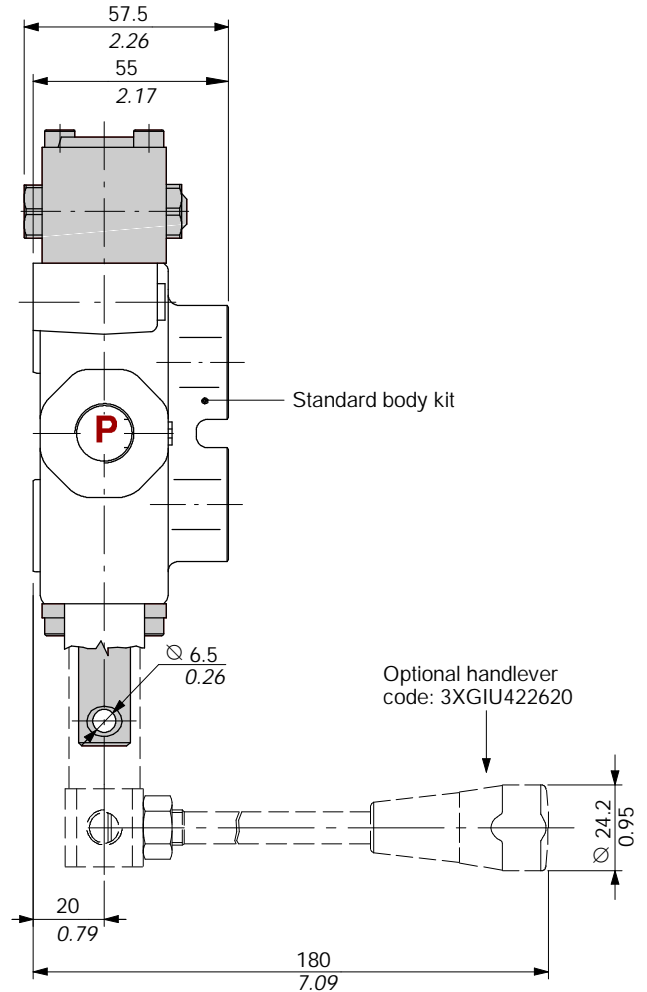
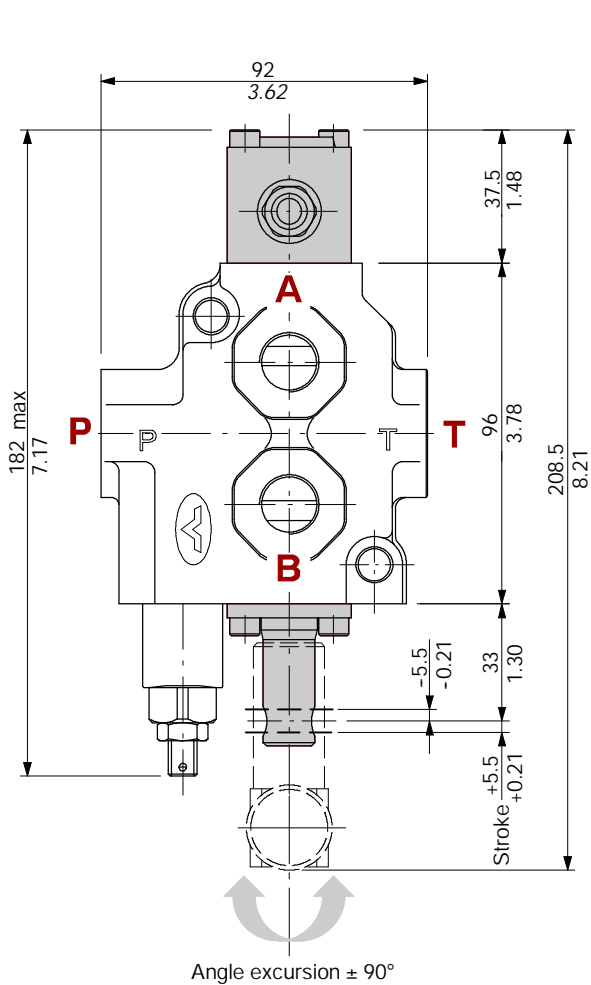

Ex.: SD4/1 (KG3-120)/ 1N R SLP

- Dust proof plate kit: code 5COP105000
- Rotary positioner kit: code 5ROT104000
- Spool: code 3CU1110561 (negative overlap)

Special configurations

Detent with kick-out from position 1 to neutral position

Spool control kit with fix setting, available with kick-out pressure of 63 and 80 bar (900 and 1150 psi).

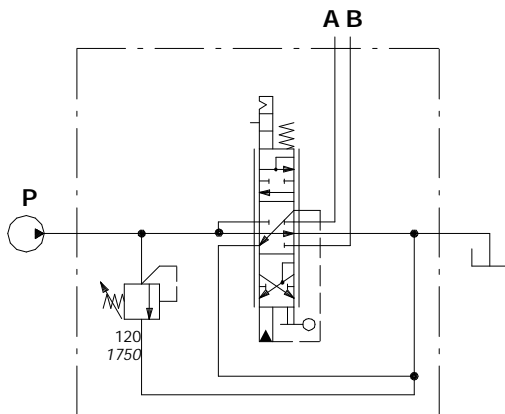
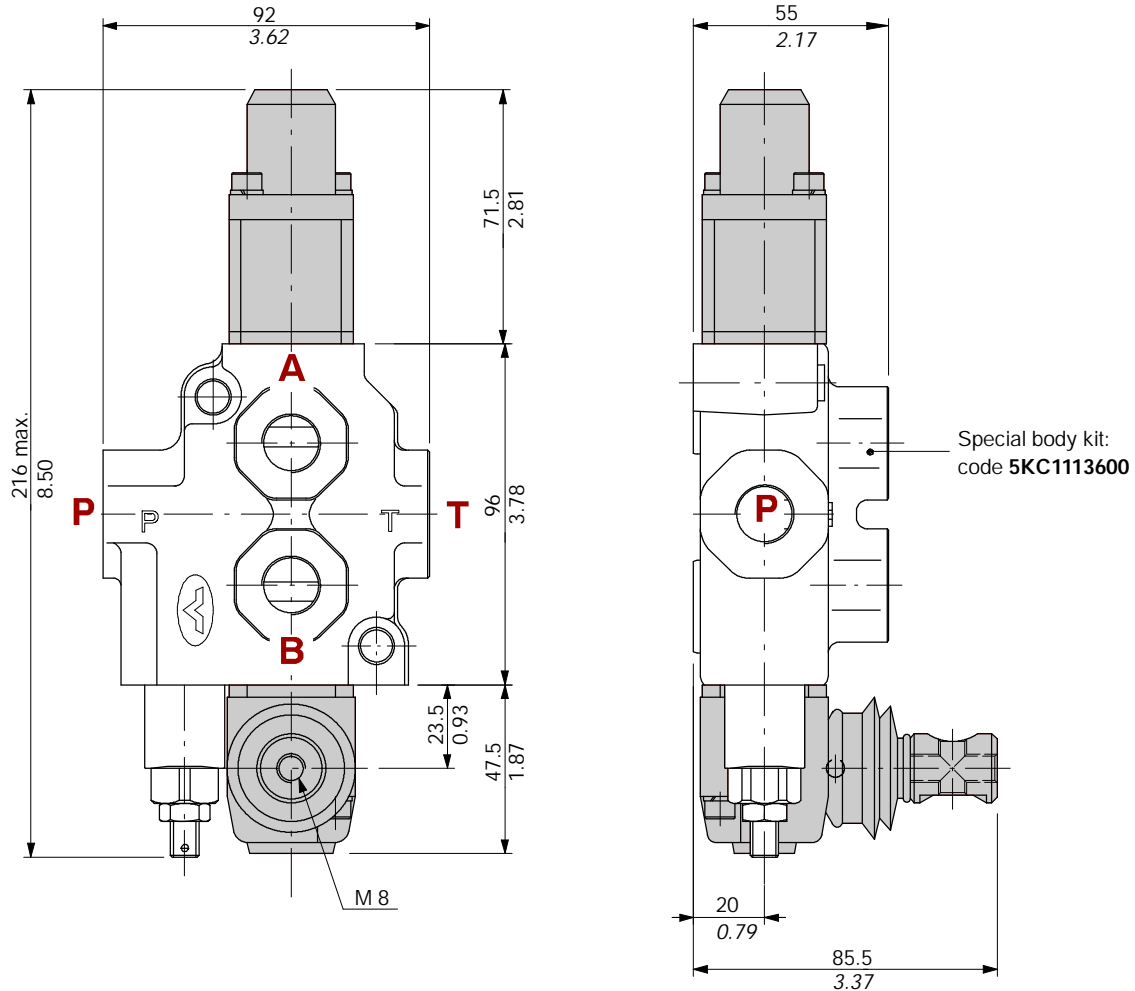

Ex.: SD4/1 (KG3-120)/ 1N 9A(80) LA

- Special lever box: code **5LEV104000**
- Positioner kit with 63 bar / 900 psi setting code **5V09504000**
- Positioner kit with 80 bar / 1150 psi setting code **5V09504080**
- Spool: code **3CU1110300** (negative overlap)

Installation and maintenance

The SD4 valve is assembled and tested as per the technical specification of this catalogue.

Before the final installation on your equipment, follow the below recommendations:

- the valve can be assembled in any position, in order to prevent body deformation and spool sticking mount the product on a flat surface;
- in order to prevent the possibility of water entering the lever box and spool control kit, do not use high pressure wash down directly on the valve;
- prior to painting, ensure plastic port plugs are tightly in place.

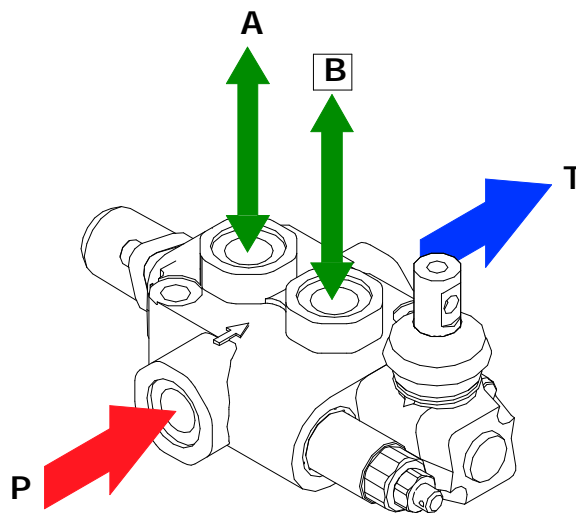

Fitting tightening torque - Nm / lbft

THREADS TYPE	P port	A and B ports	T port
BSP (ISO 228/1)	G 3/8	G 3/8	G 3/8
With O-Ring seal	35 / 25.8	35 / 25.8	35 / 25.8
With copper washer	40 / 29.5	40 / 29.5	40 / 29.5
With steel and rubber washer	30 / 22.1	30 / 22.1	30 / 22.1
UN-UNF (ISO 11926-1)	3/4-16 UNF-2B (SAE 8)	9/16-18 UNF-2B (SAE 6)	3/4-16 UNF-2B (SAE 8)
With O-Ring seal	50 / 36.9	30 / 22.1	50 / 36.9
METRIC (ISO 262)	M18 x 1.5	M18 x 1.5	M18 x 1.5
With O-Ring seal	35 / 25.8	35 / 25.8	35 / 25.8
With copper washer	40 / 29.5	40 / 29.5	40 / 29.5
with steel and rubber washer	40 / 29.5	40 / 29.5	40 / 29.5

NOTE - These torque are recommended. Assembly tightening torque depends on many factors, including lubrication, coating and surface finish. The manufacturer shall be consulted.



WALVOIL S.P.A.

42100 REGGIO EMILIA • ITALY • VIA ADIGE, 13/D
TEL. +39.0522.932411 • FAX +39.0522.300984
E-MAIL: INFO@WALVOIL.COM • HTTP: //WWW.WALVOIL.COM

SALES DEPARTMENT

TEL. +39.0522.932555 • FAX +39.0522.932455

DAC002E